

28220

RELAY BOX "MINI" 10-30 V DC/AC

Technical data

Current consumption	@12 VDC - 11.7 mA , @24 VDC - 23.2 mA, @12 VAC - 28.6 mA, @24 VAC - 59.2 mA
Dimensions (L x W x H) mm	58 x 76 x 27
Cable dimension - screw terminals	0,14 - 1 mm ²
Input max. load	60 V / 2 A
Tamper switch max. load	50 mA
Min. relay voltage	10 V

**Complete junction box for installation of alarm and access systems.**

Anti-tampering protected junction box, 10-30V DC/AC, 1 relay with 2-pole switching.

LED in series with relay coil.

4 spare terminals available for further connections.

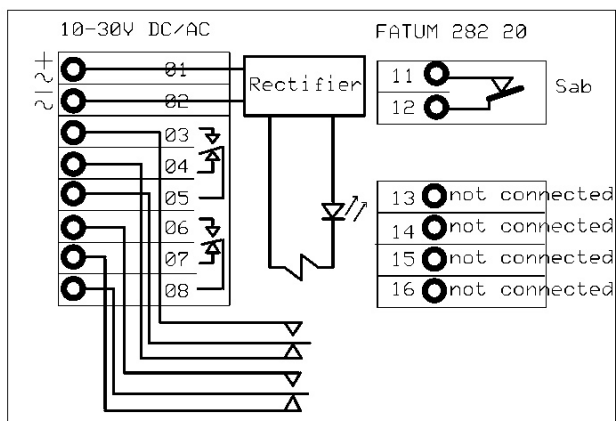

The box is flame-retardant according to UL 94 V-0.

The terminal has screw connection with elevator function.

**ORDERING INFORMATION**

Model	Description
28220.03	Relay Box Mini; 10-30 V, DC/AC; Tamper Protected; Screw

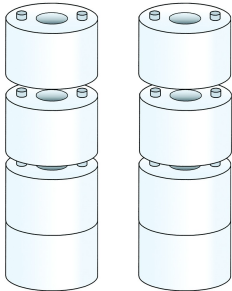
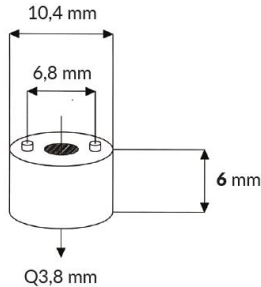
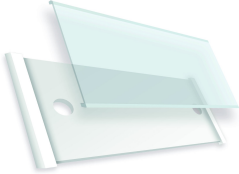
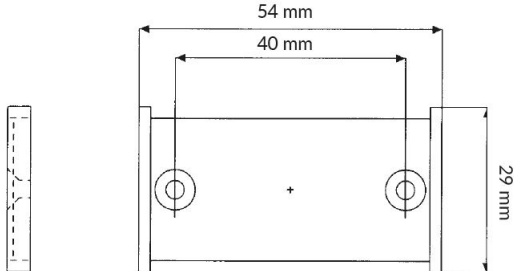
Related products and accessories

	<p>2581.06</p> <p>STACKABLE WALL SPACERS FOR EASY WIRING IN BOX</p>	
	<p>3132.01</p> <p>WALL LABEL FOR EASY LABELING</p>	
	<p>0501.01</p> <p>LSA TOOL FOR KRONE LSA PLUS CONTACTS</p>	
	<p>1901.12</p> <p>SPARE SPRINGS TO FATUM-SERIES</p>	