

28028

## ALARM BOX "MINI" 20 POLES

## Technical data

Dimensions (L x W x H) mm	58 x 76 x 27
Cable dimension - LSA slots (mm)	Ø 0,4 - 0,7
Cable dimension - screw terminals	0,14 - 1 mm <sup>2</sup>
Input max. load	60 V / 2 A
Tamper switch max. load	50 mA
Anti-tamper protection	Yes



## Complete junction box for installation of alarm and access systems.

Anti-tampering protected 16 pairs junction box.

4 pcs 1 Kohm termination resistors is mounted on the terminal block.

The terminal block has 16 parallel connected terminals, of which 1 pair is intended for anti-tamper switch connection. The box is flame-retardant according to UL 94 V-0.

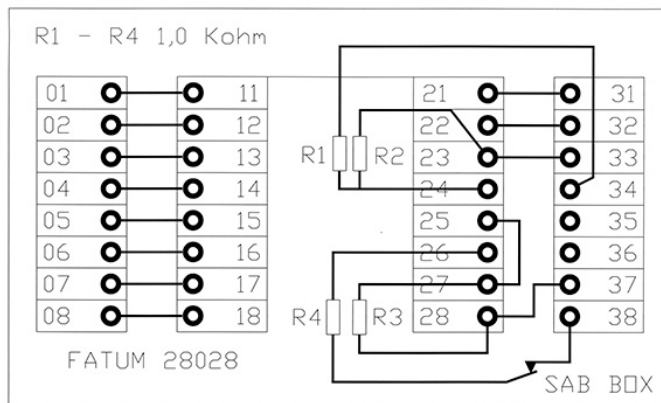

Available in different options, slot (LSA) or screw connection with lift function.



## ORDERING INFORMATION

Model	Description
28028.01	Alarm Box Mini; 16 pairs; 1 Kohm; Tamper Protected; LSA / LSA
28028.03	Alarm Box Mini; 16 pairs; 1 Kohm; Tamper Protected; Screw / Screw

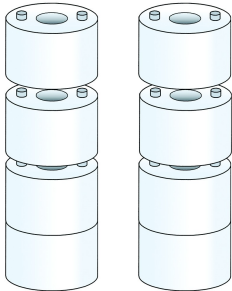
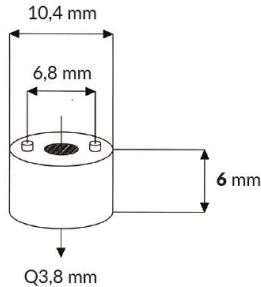
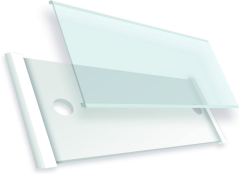
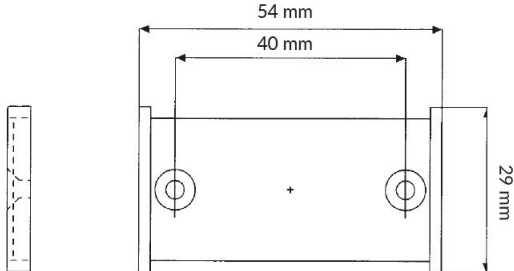
## Related products and accessories

	<p><b>2581.06</b></p> <p>STACKABLE WALL SPACERS FOR EASY WIRING IN BOX</p>	
	<p><b>3132.01</b></p> <p>WALL LABEL FOR EASY LABELING</p>	
	<p><b>0501.01</b></p> <p>LSA TOOL FOR KRONE LSA PLUS CONTACTS</p>	
	<p><b>1901.12</b></p> <p>SPARE SPRINGS TO FATUM-SERIES</p>	