

28112

ALARM BOX "MINI" 12 POLES

Technical data

Dimensions (L x W x H) mm	58 x 76 x 27
Cable dimension - screw terminals	0,14 - 1,5 mm ²
Input max. load	60 V / 2 A
Tamper switch max. load	50 mA
Anti-tamper protection	Yes



Complete junction box for installation of alarm and access systems.

Anti-tampering protected junction box with 12 single pole terminals.

The terminal block is adapted to easily connect peripherals such as Alarmtech's magnetic contacts and glass break detectors.

The terminal block has 12 connections, 2 of which are intended for anti-tamper switch connection.

The box is flame-retardant according to UL 94 V-0.

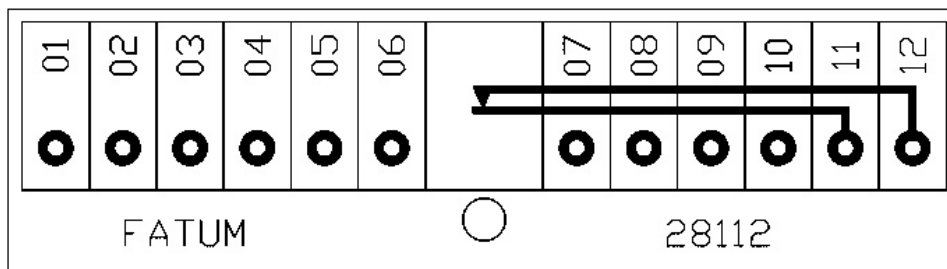

The terminal has up to 1.5 mm² screw connection with elevator function.



ORDERING INFORMATION

Model	Description
28112.03	Alarm Box Mini; 12 poles; Tamper Protected; Screw terminal

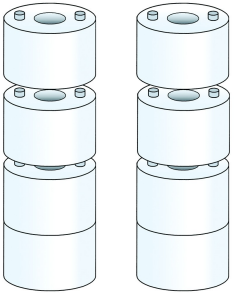
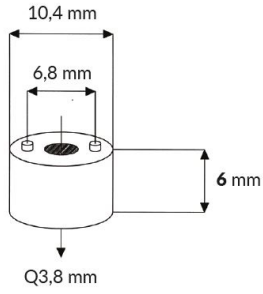
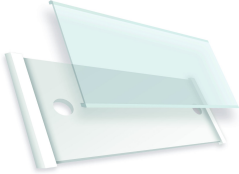
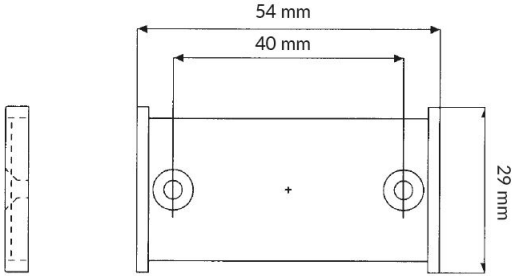
Related products and accessories

	<p>2581.06</p> <p>STACKABLE WALL SPACERS FOR EASY WIRING IN BOX</p>	
	<p>3132.01</p> <p>WALL LABEL FOR EASY LABELING</p>	
	<p>1901.12</p> <p>SPARE SPRINGS TO FATUM-SERIES</p>	