

# PSV 24130-12

## Power supply unit, ViP, 24 V 13 A

### Technical data

Approvals	EN 61000-6-1:2007, EN 61000-6-3:2007 +A1, EN 60950-1:2006+A11+A1+A12+A2, CB TEST
Supply voltage	230 VAC
Output voltage	27,6 VDC
Output current	13 A
Space for accumulator (not included)	two 12 V/12 Ah
Tamper protection	Opening and pry off switches
Housing material	Metal
Colour	White
Dimensions (L x W x H) mm	470 x 370 x 140



Power supply unit with ViP (Voltage in Parallel) function, 24 VDC 13 A.

Power supply unit with ViP function can be connected in parallel to provide more power and redundancy and compensate for voltage drop in the cables. Space is provided for two 12 V/12 Ah accumulators in the metal box which also has opening and pry-off switches. The unit is protected against short-circuiting and overload. Mains failure, low output voltage, battery and fuse failure is indicated via LED and activates separate outputs with relays.

Related products and accessories

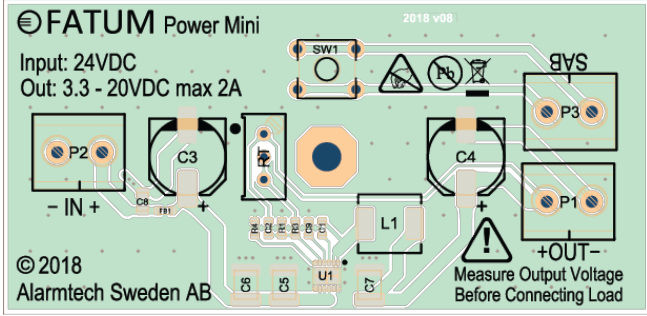
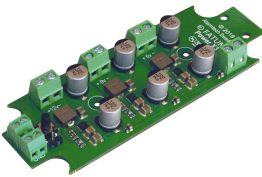
	<p><b>28097</b></p> <p>DC/DC Converter MINI 5-32 V -&gt; 3-30 V</p>	
	<p><b>3097</b></p> <p>Power X3 Terminal block for installation of alarm and access systems</p> <p>DC / DC Converter 12-24 VDC -&gt; 5V, 9V, 12V</p>	