

# JB 370-2

## Junction Box for GD 370 and GD 470 Glass Break Detectors

### Technical data

|                           |                 |
|---------------------------|-----------------|
| Contact rating            | 48 VDC / 100 mA |
| Tamper protection         | Yes             |
| Housing material          | ABS Plastic     |
| Colour                    | White           |
| Dimensions (L x W x H) mm | 90 x 66 x 30    |



JB 370-2 is a junction box which simplifies the installation of the GD 370 glass break detector. The junction box connects max 2 GD 370 with IU 370 and/or multiple JB 370/JB 370-2/JB 370-5. JB 370-2 is equipped with a built-in resistor for termination of glass break (optional with jumper). It also has tamper protection.



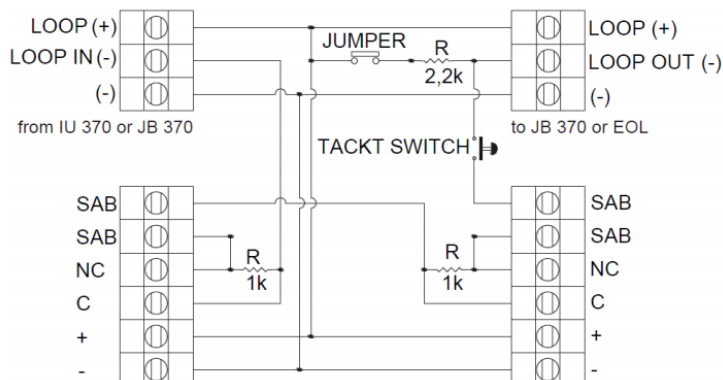



When installing multiple GD 370 in a location which allows for a common junction point JB 370-2 is an excellent choice of junction box.

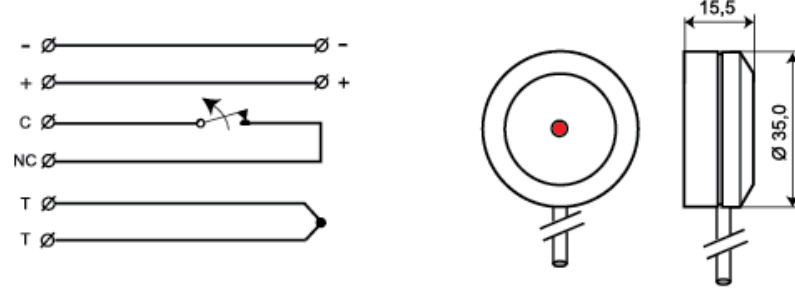

### ORDERING INFORMATION

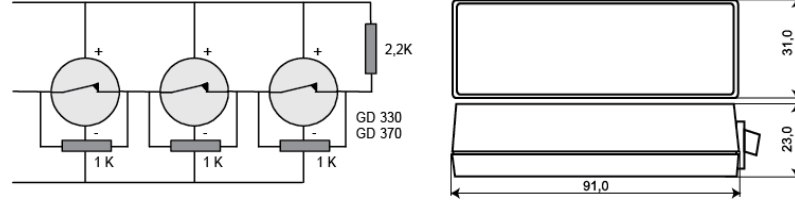
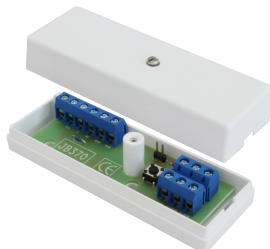
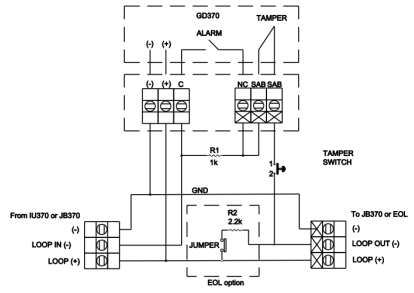
| Model  | Description             |
|--------|-------------------------|
| JB 370 | Junction box for GD 370 |

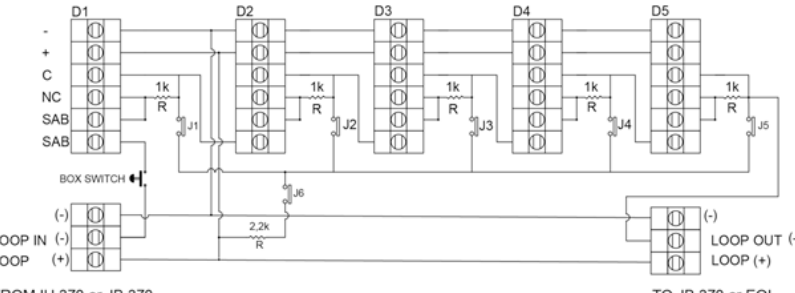
Related products and accessories

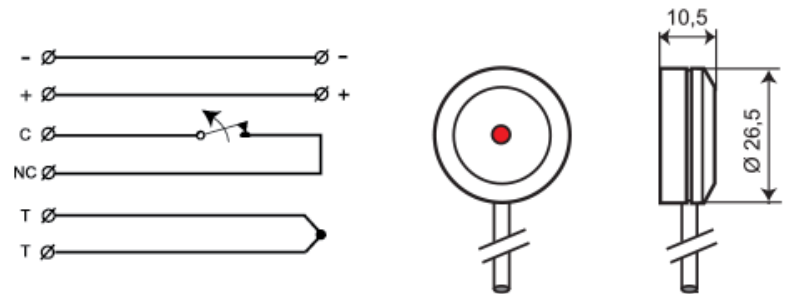
|   |   |   |
|---|---|---|
|    | <p><b>GD 370</b></p> <p><b>DISCONTINUE</b><br/> <b>D</b> - Replaced by <a href="#">GD 470</a></p> <p>Glass Break Detector for Laminated Glass, Glued</p>            |  <p>Wiring diagram showing terminals: -, +, C, NC, T, T. Dimensions: 15,5 mm width, 35,0 mm height.</p>                               |
|    | <p><b>IU 370</b></p> <p>Interface unit for GD 330/ GD 370/ GD 470</p>   |  <p>Wiring diagram showing resistors (1K, 2.2K) and terminals 1, 3, 4. Dimensions: 91,0 mm length, 31,0 mm height, 23,0 mm depth.</p> |
|   | <p><b>JB 370</b></p> <p><b>DISCONTINUE</b><br/> <b>D</b> - Replaced by <a href="#">JB 370-2</a></p> <p>Junction Box for GD 370 and GD 470 Glass Break Detectors</p> |  <p>Wiring diagram showing connections for GD370, ALARM, TAMPER, NC, SAB, SAB, R1, R2, JUMPER, LOOP IN, LOOP, and EOL option.</p>    |
|  | <p><b>JB 370-5</b></p> <p>Junction Box for GD 370 Glass Break Detector</p>  |  <p>Wiring diagram showing terminals D1-D5, LOOP IN, LOOP, BOX SWITCH, and connections to JB 370 or EOL.</p>                        |
|  | <p><b>GD 470</b></p> <p>Glass Break Detector for Laminated Glass, Glued, Relay output</p>   |  <p>Wiring diagram showing terminals: -, +, C, NC, T, T. Dimensions: 10,5 mm width, 26,5 mm height.</p>                             |